

RERA REGISTRATION NO.:
RC/REP/HARERA/GGM/868/600/2024/95 DATED 20.09.2024
RC/REP/HARERA/GGM/869/601/2024/96 DATED 20.09.2024
(WWW.HARYANARERA.GOV.IN)



**SIGNATURE™
GLOBAL**

REALTY. RELIABILITY. RESPONSIBILITY.

AN ISO 9001:2015; 14001:2015; 45001:2018; 27001:2022 CERTIFIED COMPANY



OUR LEGACY OVER THE YEARS

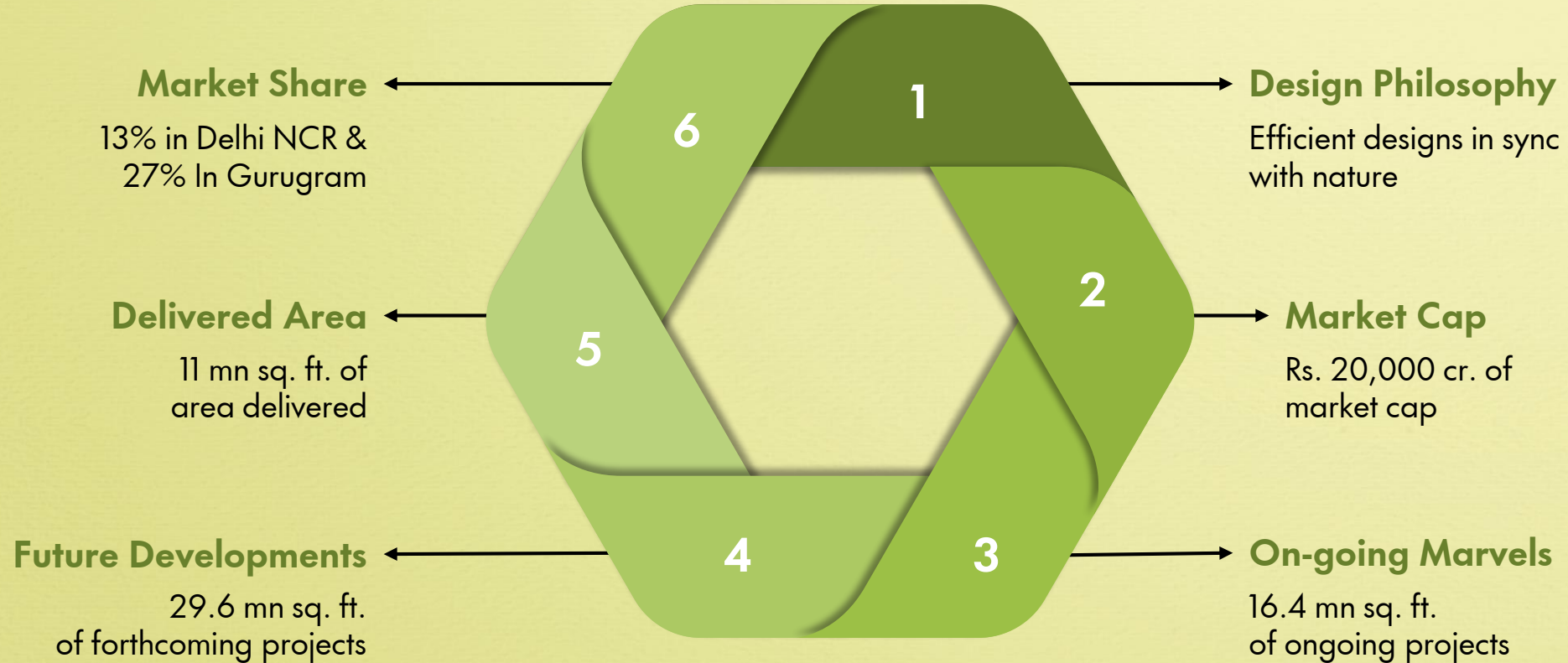

WITH OUR FOOTPRINTS ACROSS GURUGRAM

Golf Course
Road Extn.

01

Southern
Peripheral Road

02

New
Gurugram

03

Dwarka
Expressway

04

South of
Gurugram

05





**NOW DEVELOPING ONE OF
THE LARGEST TOWNSHIP**

TOWNSHIP



— At One Of The Most Iconic Location —

GURUGRAM'S X FACTOR



GURUGRAM'S BEST KEPT SECRET



One of the Greenest Area as it is located at the foothills of the Aravallis



Connected to Golf Course Road, Delhi and major parts of NCR



Promising business ecosystem



Great social and civic infrastructure



Metro's Yellow Line extn. proposed from HUDA City Centre towards Sohna-Gurgaon Road



Connected via Gurugram – Sohna Elevated Road & located bang on Delhi-Vadodara-Mumbai Expressway

A LOCATION THAT IS HOME TO THE MOST PRESTIGIOUS DEVELOPMENTS

Approx. **2,344** units were launched in the price bracket of **Rs. 5 cr** in H1, 2024



Source: [Medium](#)

WITH PRICES SOARING TO NEW HEIGHTS

Short Term Rise

Over the past year alone, prices have risen by 20.5%

Long Term Rise

An impressive 137.3% increase over the last five years

Independent Floors

39.2% price growth seen in the last 3 years

Opportunity

Rise in investment with hassle free traffic due to Gurugram-Sohna elevated corridor

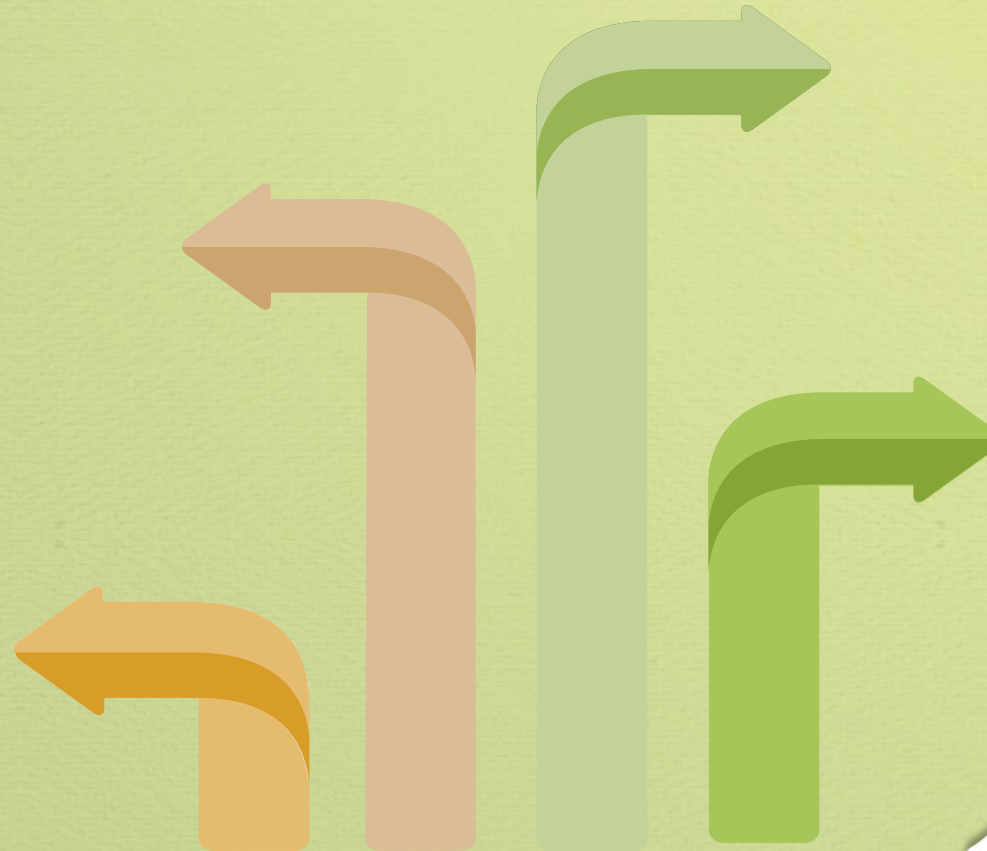



**INTRODUCING THE NEXT BIG THING IN
GURUGRAM'S X FACTOR**

X FACTOR



How South of Every City Has Seen the Most Premium Developments



**South
Mumbai**



**South
Delhi**



**South
London**



**South End
Boston**



HERE'S ANOTHER ONE IN GURUGRAM'S X FACTOR

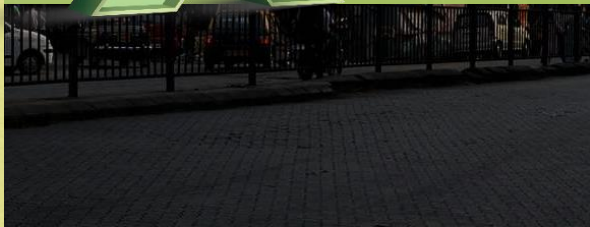



WHERE YOU BUILD THE
PERFECT EQUATION OF LIFE





**AN INTEGRATED TOWNSHIP
WHERE YOU..**

TOWNSHIP



ADD

EVERY JOY TO YOUR LIFE



SUBTRACT

STRESS FROM YOUR LIFE



MULTIPLY

YOUR OPPORTUNITIES



DIVIDE

TIME BETWEEN
WORK & LEISURE





AN ICONIC LOCATION

LOCATION



ADD CONVENIENCE, SUBTRACT COMMUTE



5 Mins to
Golf Course Road Extn.

9 Mins
to Subhash Chowk

10 mins
to SPR

15 Mins
to Rajiv Chowk

30 Mins
to Airport

**Right on Delhi -
Vadodara-Mumbai
Industrial Corridor**

**Hassle free drive via
Gurugram-Sohna Elevated Road
to Badshahpur Chowk**

Map Not to Scale



**AN ECOSYSTEM
BUILT TO THRIVE**

ECOSYSTEM



LIFE IN A GIST AT DAXIN



The Lap
of Nature

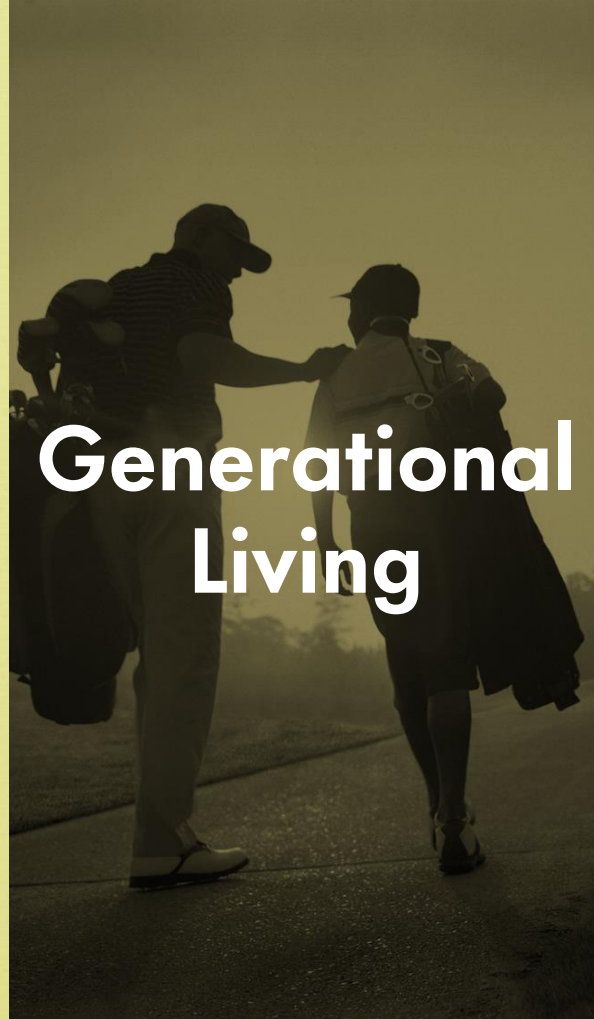

Generational
Living



Community
Life



Social
Fabric





ADD MORE NATURE TO LIFE

52 Meters of Lush Green Boulevards





Sculpture Gardens



Butterfly Garden





Miyawaki Forest



Reflexology Park





Scented Hedge Garden



Nature Court



ADD MORE OXYGEN, SUBTRACT POLLUTION AN ADDRESS SURROUNDED BY ARAVALIS



MULTIPLY BENEFITS ACROSS GENERATIONS



Kids



Teenagers



Millennials



Senior Citizens

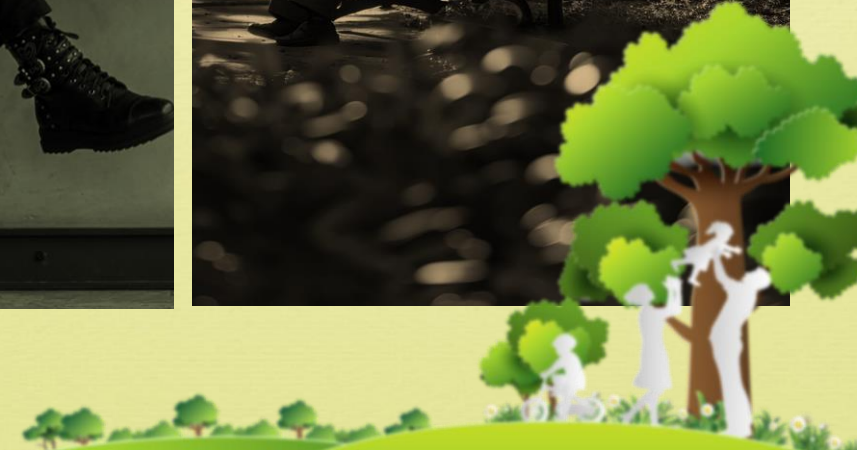



**ADD JOY,
SUBTRACT CHAOS**

ADD JOY





Kids Outdoor Play Area



Sand Pit



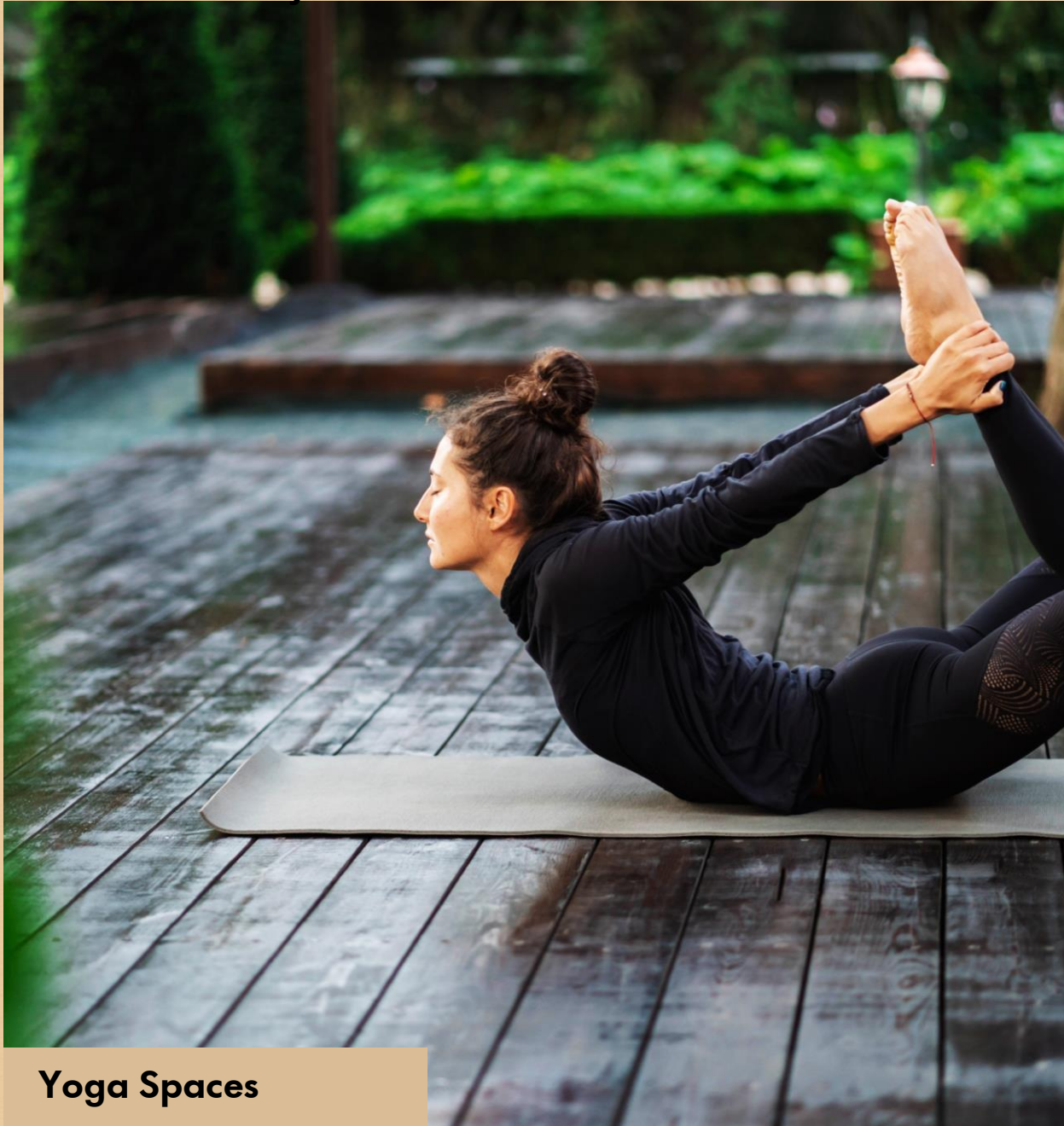

Yoga Spaces



Recessed Park





Games Arena



Jogging Track



**ADD SOCIAL SPACES,
MULTIPLY YOUR
CONNECTIONS**

CONNECTIONS





Outdoor Seating Area

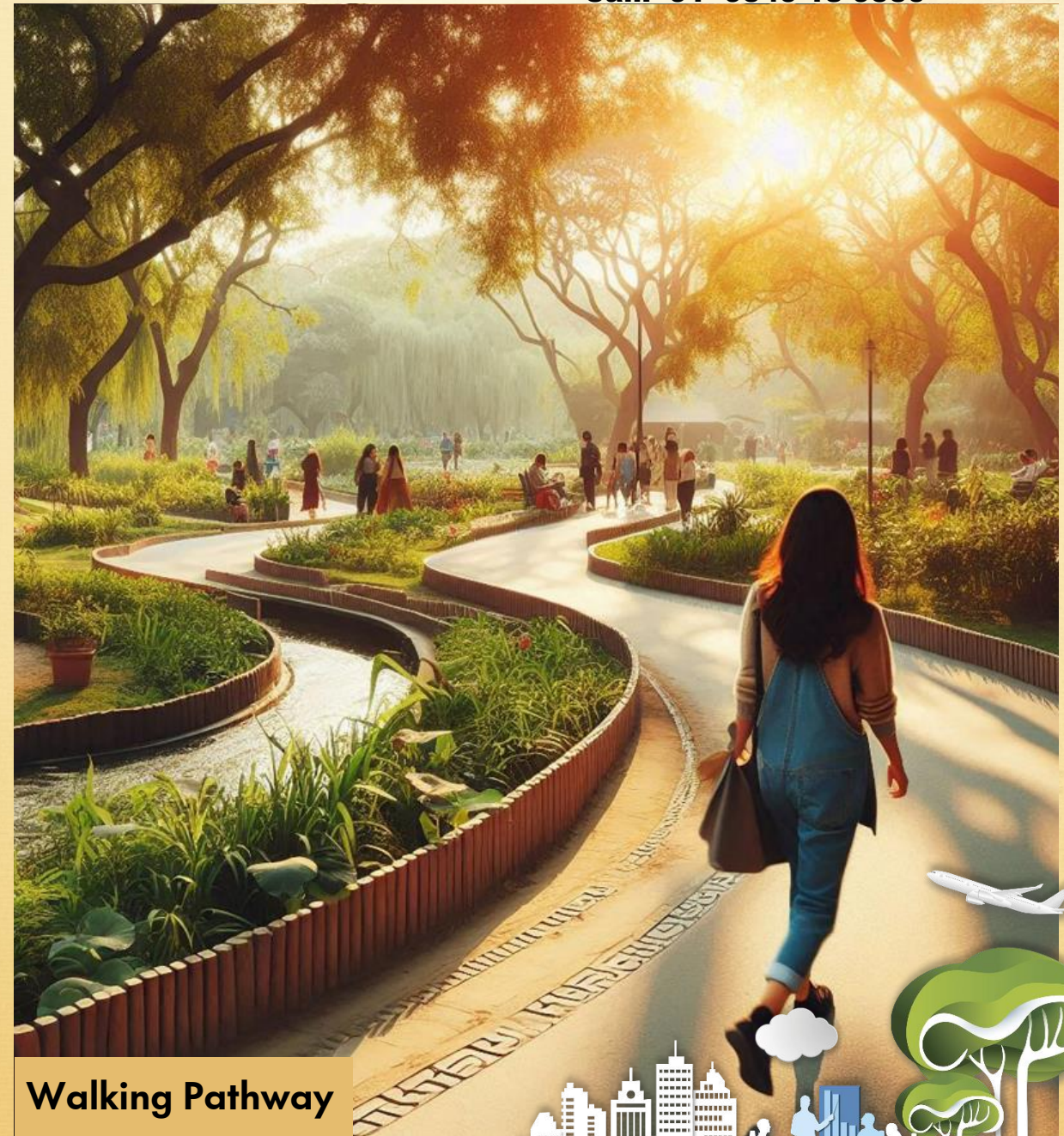

Walking Pathway





**ADD KNOWLEDGE,
SUBTRACT WORRIES**

KNOWLEDGE





2 Acres of Space Dedicated to A+ Premier School





Dedicated Parking Area

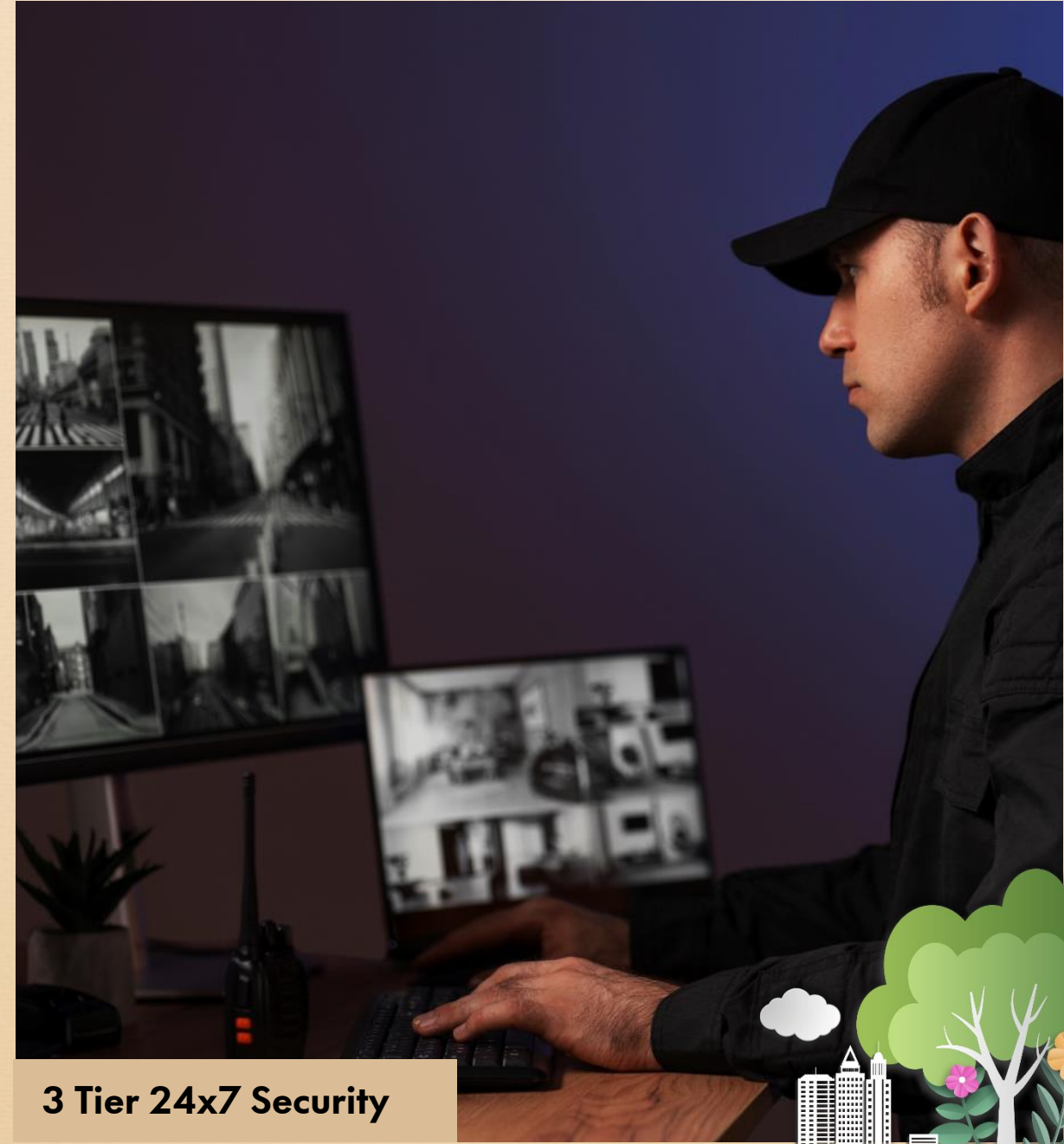

3 Tier 24x7 Security





**MULTIPLY YOUR
JOY & LEISURE**

JOY & LEISURE





Shopping



Dining

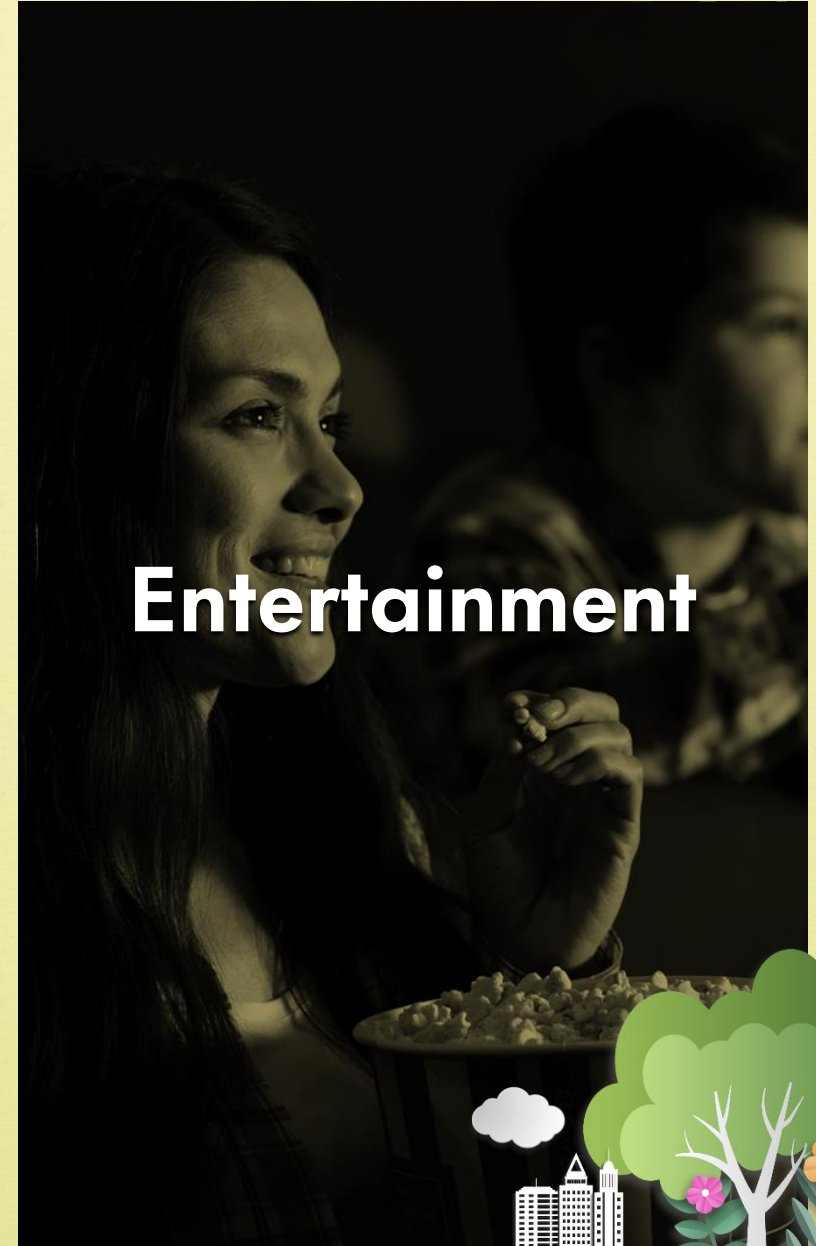

Entertainment





THE OPPORTUNITY TO INVEST IN..

INVESTMENT





PRESENTING
INDEPENDENT PREMIUM FLOORS

VISTAS



S+4 FLOORS



Wide Driveways

Pedestrian Zones of 22 Kms*



ADD GREEN LIVING

52 meter Wide
Green Boulevards



EXPERIENCE A GRAND LIFE
LIKE NEVER BEFORE



DIVIDE TIME BETWEEN WORK & LEISURE

Luxe Club Life



Add Grandeur with a Grand Arrival

Double-height Entrance Lobby

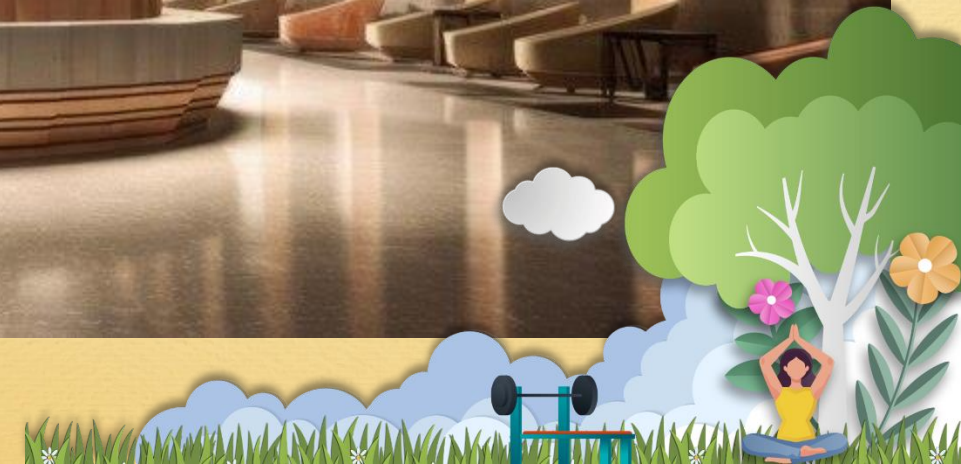
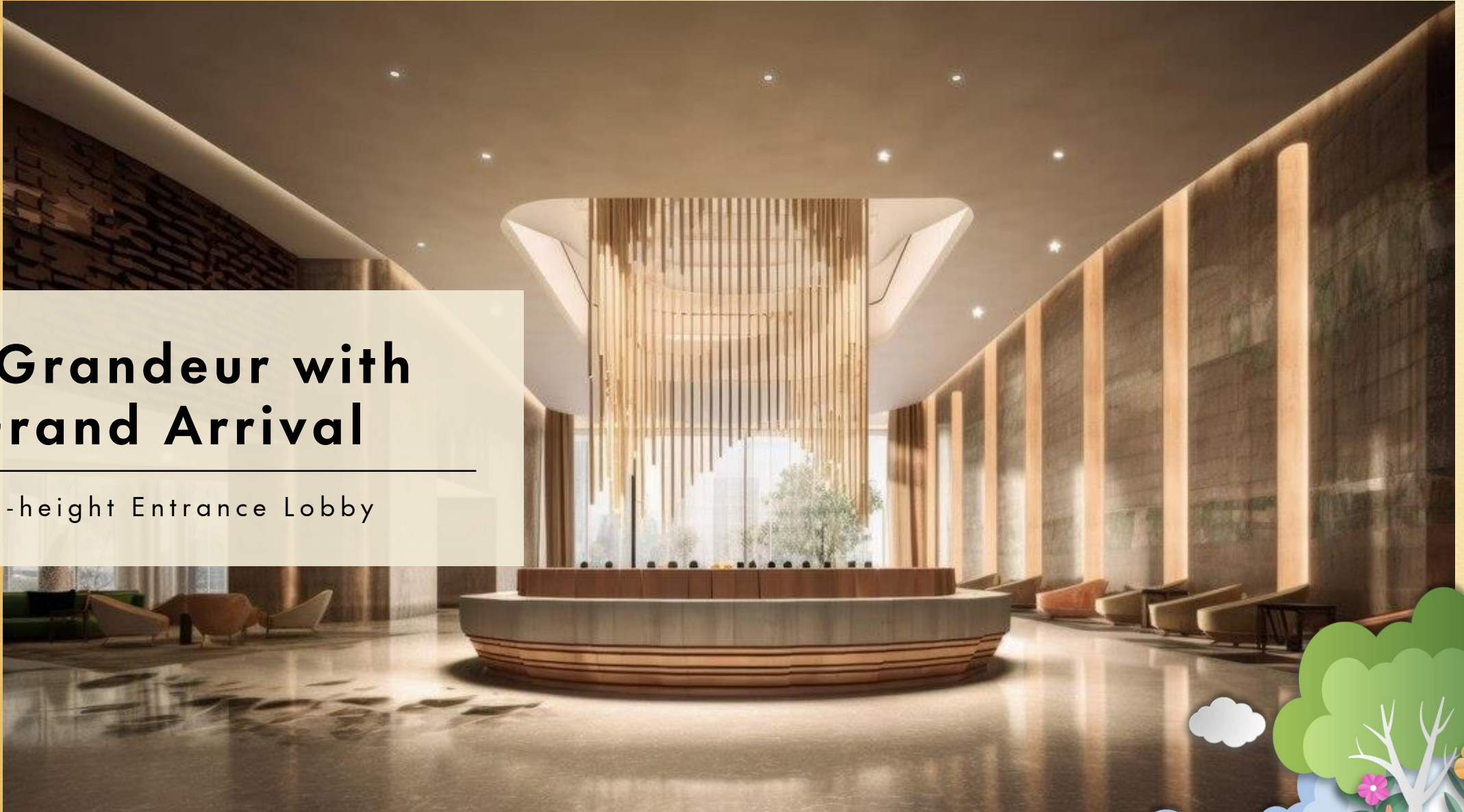



EXCLUSIVE CLUB HOUSE AMENITIES

LIFESTYLE





Swimming Pool



Gymnasium

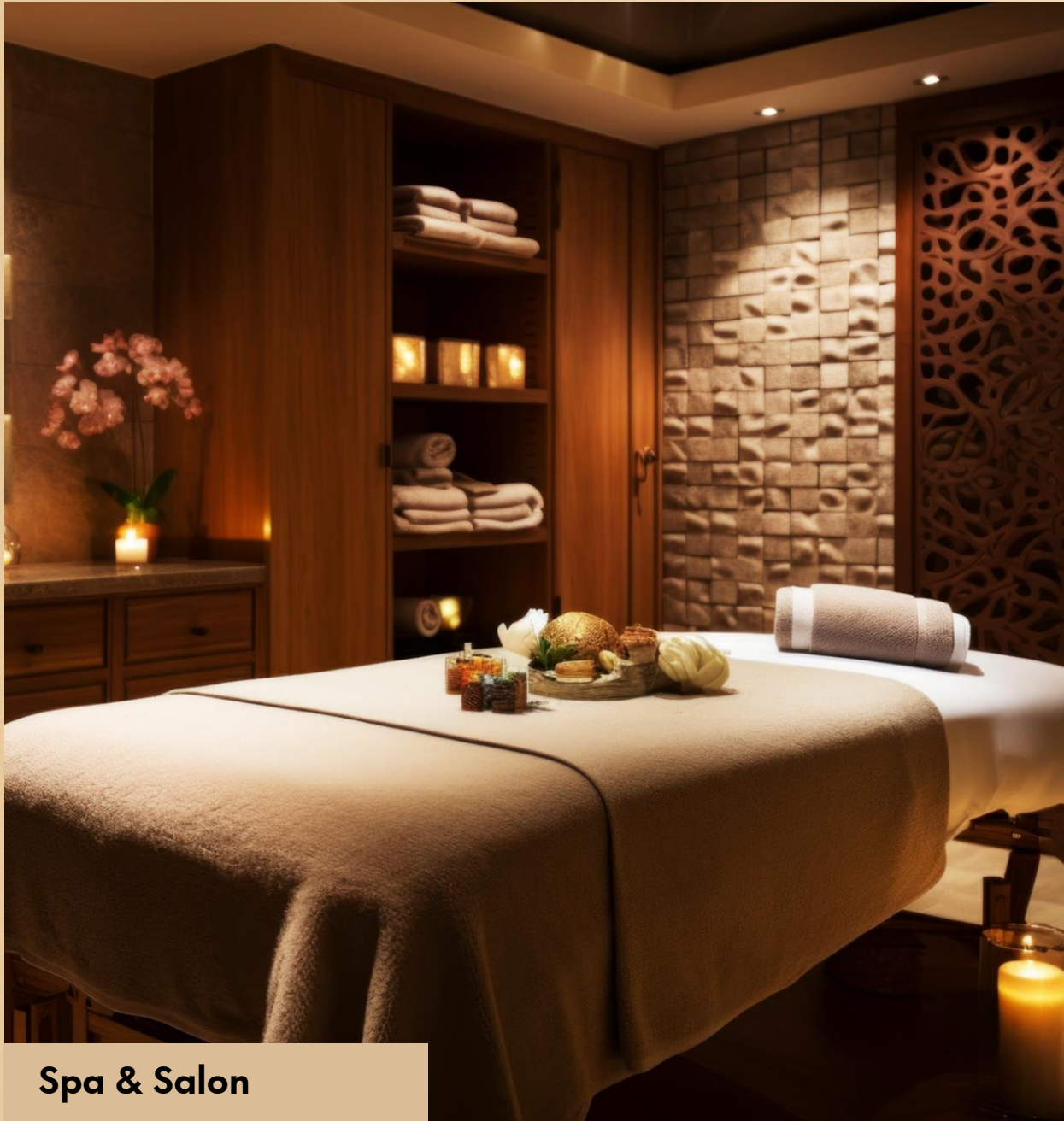

Spa & Salon

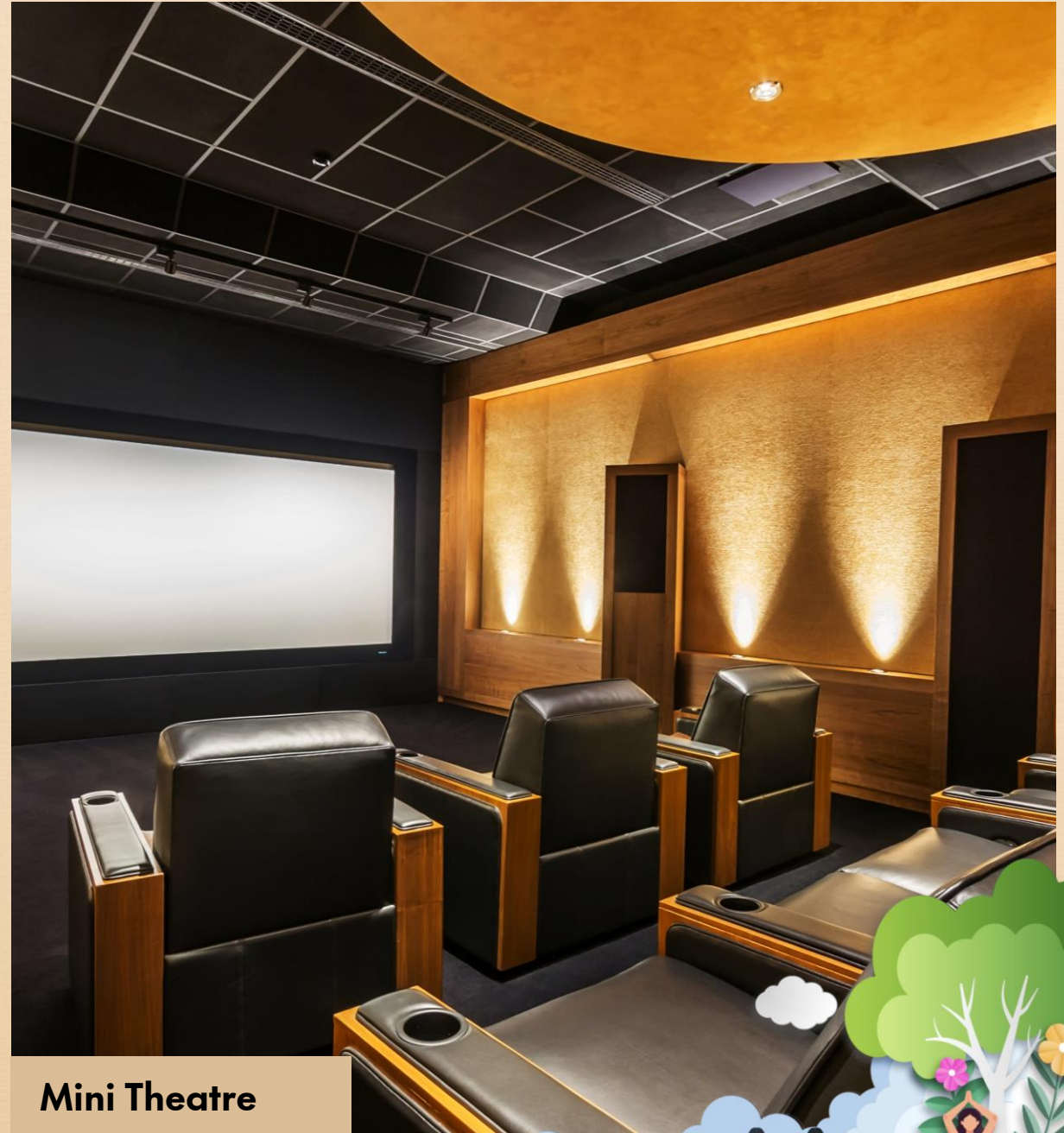

Mini Theatre





Co-working Space



Conference Room



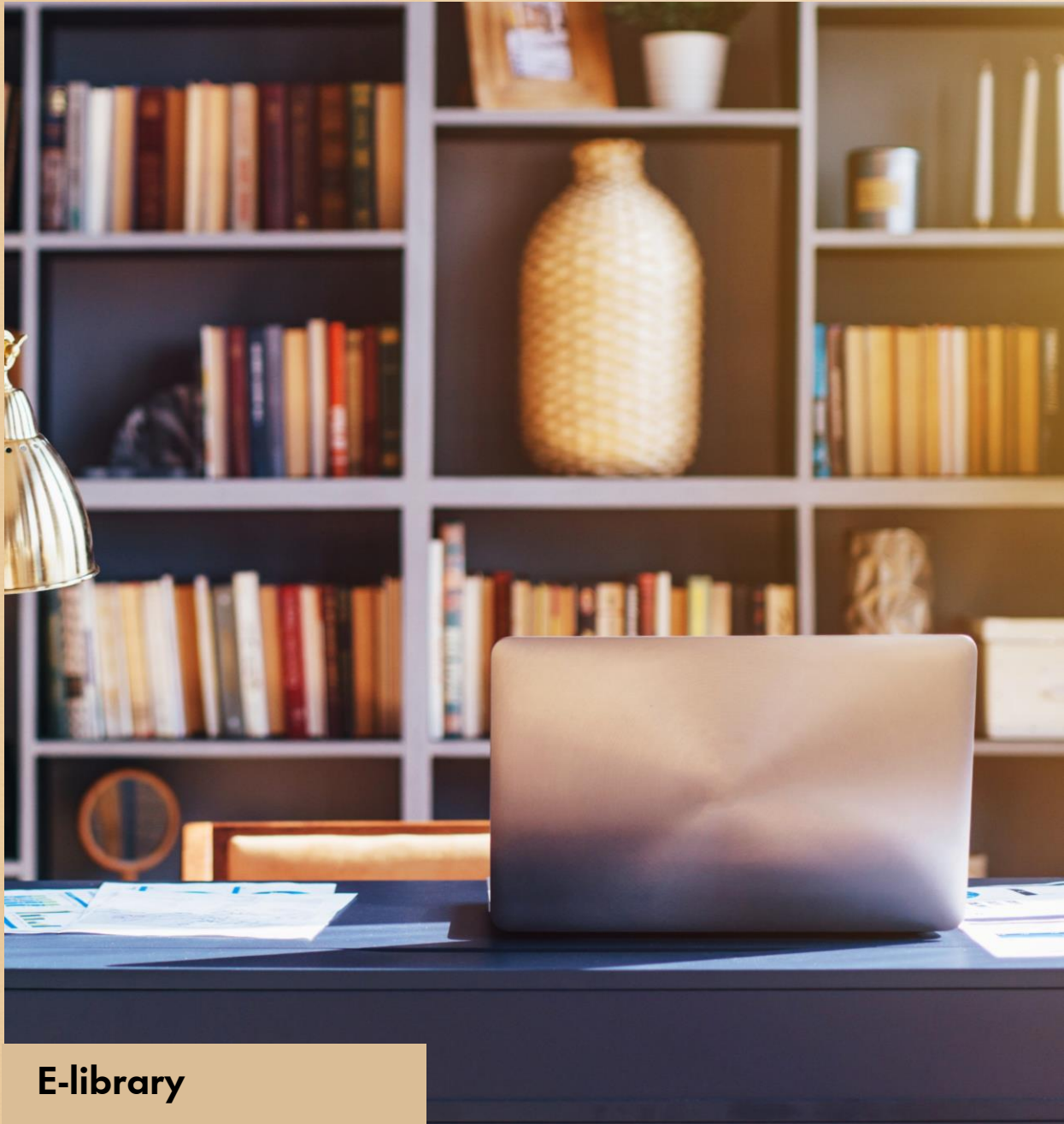

E-library

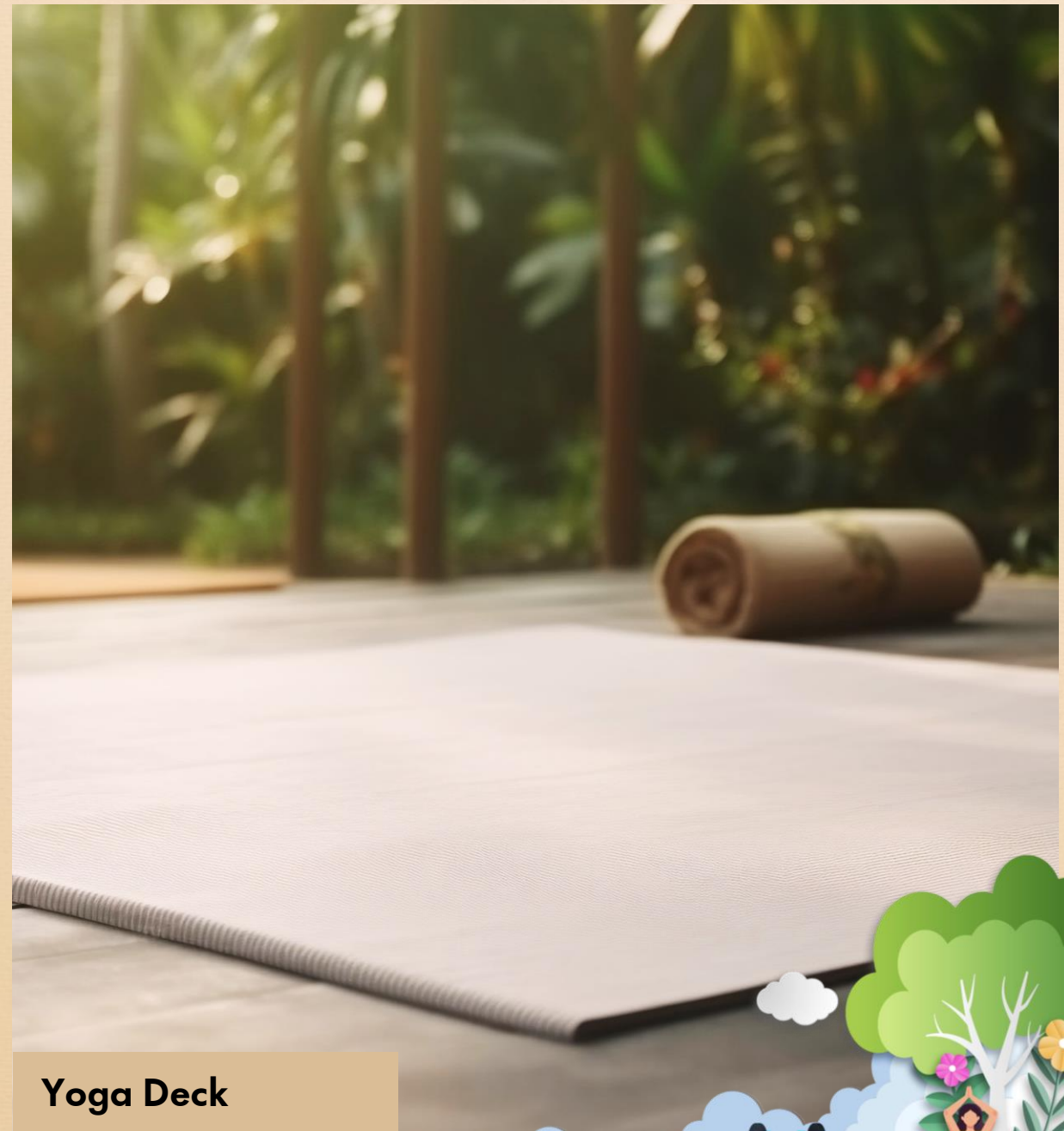

Yoga Deck



Laundromat

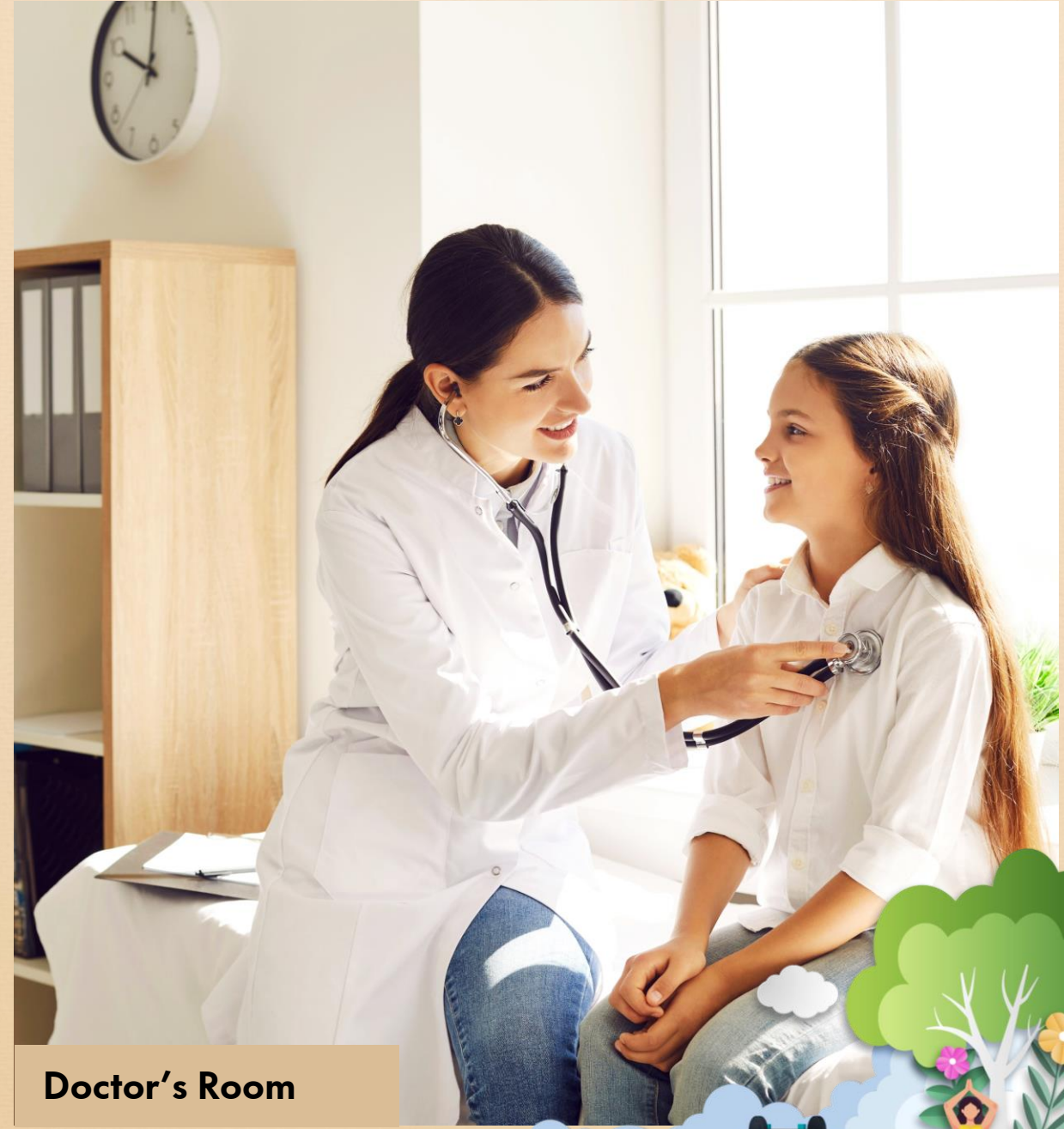

Doctor's Room





Kids Indoor Play Area





FLOOR PLAN

SITE PLAN



BASEMENT

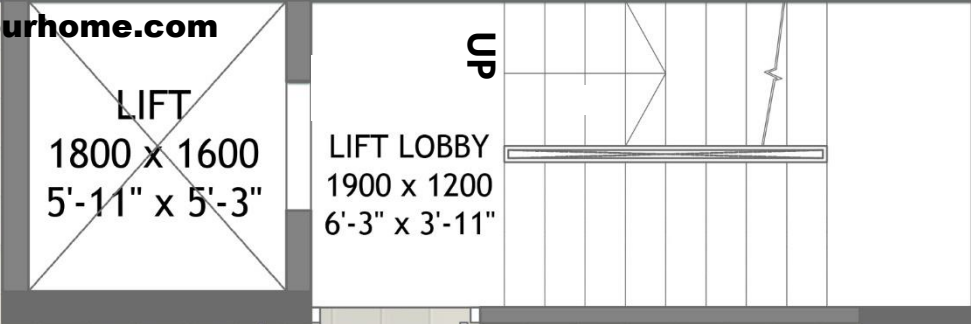

LIFT
1800 x 1600
5'-11" x 5'-3"

LIFT LOBBY
1900 x 1200
6'-3" x 3'-11"

UP
DN

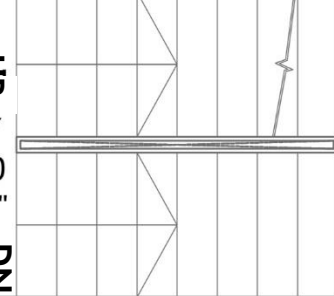

PLOT LINE

STILT PARKING

STILTS

DRIVEWAY

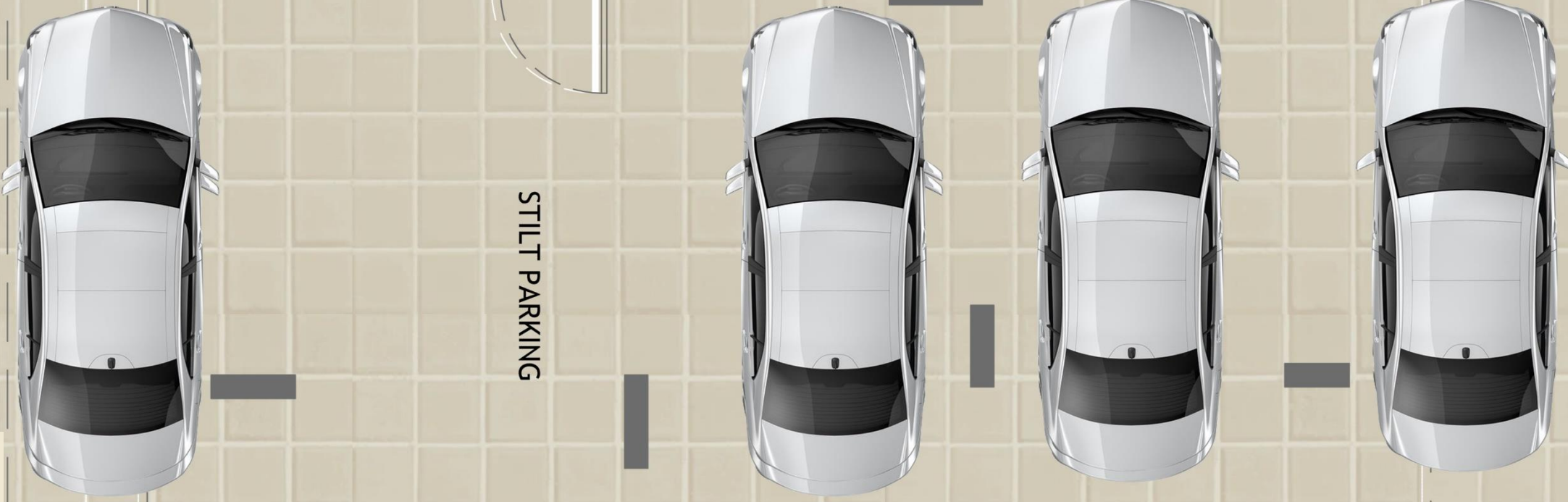

TYPICAL FLOOR PLAN

TYPE - A



PLOT LINE

PLOT LINE



THE MASTERMINDS OF TOWNSHIP

MASTERMINDS



CONCEPT

Aedas

One of the world's leading architect based out of Singapore with 12 offices and 54 recognized projects

Architect
Hafeez
Contractor

A visionary Indian architect renowned for transforming modern urban landscapes

LEAD DESIGN



A leading design firm celebrated for seamlessly blending contemporary aesthetics with sustainable architecture

LANDSCAPE ARCHITECT



Acclaimed for its holistic approach to design, integrating cutting-edge technology with cultural and contextual sensitivity

MEP CONSULTANT



Excels in blending architecture, engineering, and sustainability for high-performance, future-ready buildings

STRUCTURE CONSULTANT



Renowned for its structural engineering expertise, delivering innovative and robust solutions for complex, large-scale projects





FOR INVESTMENT

REACH OUT TO US





**SIGNATURE™
GLOBAL**

REALTY. RELIABILITY. RESPONSIBILITY.

AN ISO 9001:2015; 14001:2015; 45001:2018; 27001:2022 CERTIFIED COMPANY



SIGNATURE GLOBAL BUSINESS PARK PRIVATE LIMITED | U70109DL2019PTC346164

REGD. OFF: 13TH FLOOR, DR. GOPAL DAS BHAWAN, 28, BARAKHAMBA ROAD, CONNAUGHT PLACE, CENTRAL DELHI, NEW DELHI - 110001

CORP. OFF.: UNIT NO. 101, GROUND FLOOR, TOWER-A, SIGNATURE TOWER SOUTH CITY-1, GURUGRAM, HARYANA, INDIA, 122001 WWW.SIGNATUREGLOBAL.IN

Disclaimer : Promoter urges every applicant to inspect the project site and, therefore, requests to make personal judgment prior to submitting an application for allotment. Unless otherwise stated, all the images, visuals, materials and information contained herein are purely creative/artistic and may not be actual representations of the product and/or any amenities. Further, the actual design may vary in the fit and finished form, from the one displayed above. Journey time shown, if any, is based upon Google Maps which may vary as per the traffic at a relevant point of time. The dimensions specified, if any, are inclusive of wall-to-wall measurements, excluding finishing margins. Potential offsets within rooms may occur due to structural elements. *Rate mentioned above, if any, does not include GST and other statutory charges as applicable. T & C Apply. 1 sq. mt. = 10.7639 sq. ft.